



2SA1507/2SC3902

Bipolar Transistor

(-160V, (-)1.5A, Low $V_{CE(sat)}$, (PNP)NPN Single TO-126ML

ON Semiconductor®

<http://onsemi.com>

Applications

- Color TV audio output, converters, inverters

Features

- High breakdown voltage
- Large current capacity
- Adoption of FBET and MBIT process
- The plastic-covered heat sink eliminates the need for an insulator when mounting the 2SA1507/2SC3902

Specifications () : 2SA1507

Absolute Maximum Ratings at $T_a=25^\circ\text{C}$

Parameter	Symbol	Conditions	Ratings	Unit
Collector-to-Base Voltage	V_{CBO}		(-)180	V
Collector-to-Emitter Voltage	V_{CEO}		(-)160	V
Emitter-to-Base Voltage	V_{EBO}		(-)6	V
Collector Current	I_C		(-)1.5	A
Collector Current (Pulse)	I_{CP}		(-)2.5	A
Collector Dissipation	P_C		1.5	W
		$T_c=25^\circ\text{C}$	10	W
Junction Temperature	T_j		150	$^\circ\text{C}$
Storage Temperature	T_{stg}		-55 to +150	$^\circ\text{C}$

Stresses exceeding Maximum Ratings may damage the device. Maximum Ratings are stress ratings only. Functional operation above the Recommended Operating Conditions is not implied. Extended exposure to stresses above the Recommended Operating Conditions may affect device reliability.

Package Dimensions

unit : mm (typ)

7516A-002

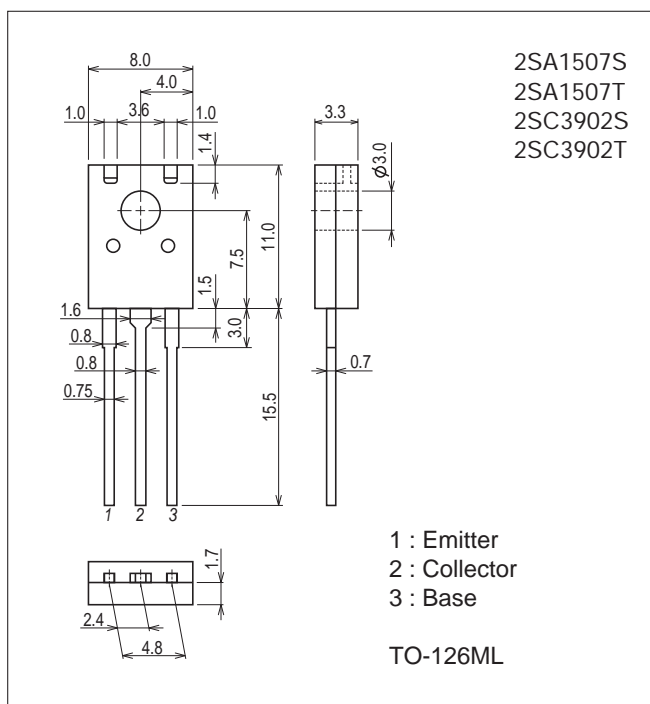

Product & Package Information

- Package : TO-126ML
- JEITA, JEDEC : TO-126
- Minimum Packing Quantity : 200 pcs./bag

Marking

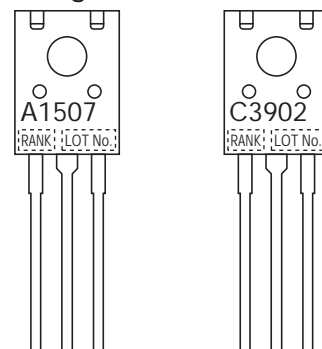

Electrical Connection

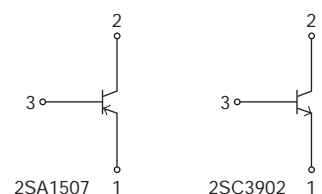

2SA1507 / 2SC3902

Electrical Characteristics at Ta=25°C

Parameter	Symbol	Conditions	Ratings			Unit
			min	typ	max	
Collector Cutoff Current	ICBO	V _{CB} =(-)120V, I _E =0A			(-)1.0	μA
Emitter Cutoff Current	I _{EBO}	V _{EB} =(-)4V, I _C =0A			(-)1.0	μA
DC Current Gain	h _{FE1}	V _{CE} =(-)5V, I _C =(-)100mA	100*		400*	
	h _{FE2}	V _{CE} =(-)5V, I _C =(-)10mA	90			
Gain-Bandwidth Product	f _T	V _{CE} =(-)10V, I _C =(-)50mA		120		MHz
Output Capacitance	C _{ob}	V _{CB} =(-)10V, f=1MHz		(22)14		pF
Collector-to-Emitter Saturation Voltage	V _{CE(sat)}	I _C =(-)500mA, I _B =(-)50mA		(-0.2)0.13	(-0.5)0.45	V
Base-to-Emitter Saturation Voltage	V _{BE(sat)}	I _C =(-)500mA, I _B =(-)50mA		(-)0.85	(-)1.2	V
Collector-to-Base Breakdown Voltage	V _{(BR)CBO}	I _C =(-)10μA, I _E =0A	(-)180			V
Collector-to-Emitter Breakdown Voltage	V _{(BR)CEO}	I _C =(-)1mA, R _{BE} =∞	(-)160			V
Emitter-to-Base Breakdown Voltage	V _{(BR)EBO}	I _E =(-)10μA, I _C =0A	(-)6			V
Turn-On Time	t _{on}	See specified Test Circuit.		(0.7)0.04		μs
Storage Time	t _{stg}			(0.7)1.2		μs
Fall Time	t _f			(0.04)0.08		μs

* : The 2SA1507 / 2SC3902 are classified by 100mA h_{FE} as follows:

Rank	R	S	T
h _{FE}	100 to 200	140 to 280	200 to 400

Switching Time Test Circuit

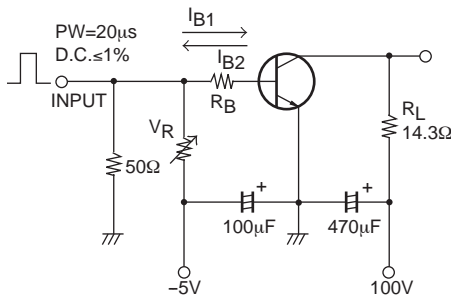

$$I_C = 10I_{B1} = -10I_{B2} = 0.7A$$

(For PNP, the polarity is reversed.)

Ordering Information

Device	Package	Shipping	memo
2SA1507S	TO-126ML	200pcs./bag	Pb Free
2SA1507T	TO-126ML	200pcs./bag	
2SC3902S	TO-126ML	200pcs./bag	
2SC3902T	TO-126ML	200pcs./bag	

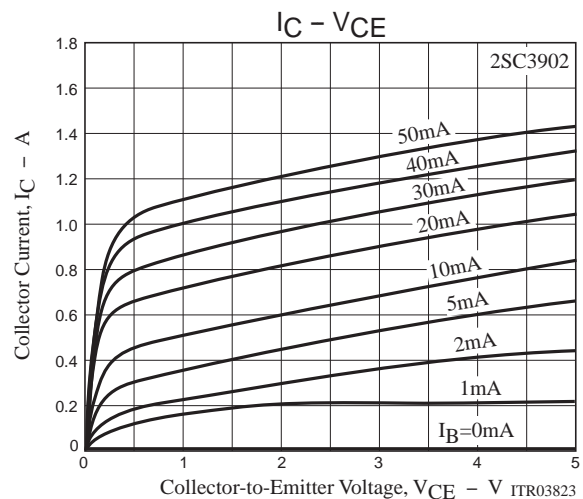
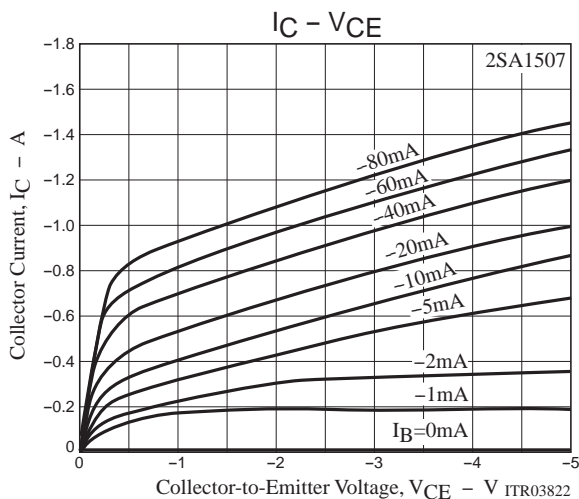

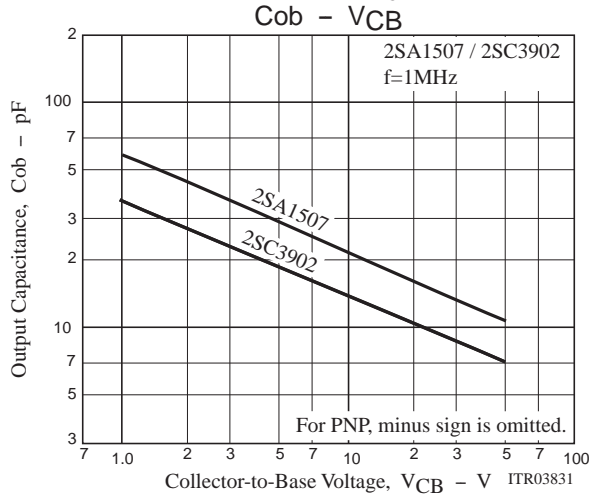
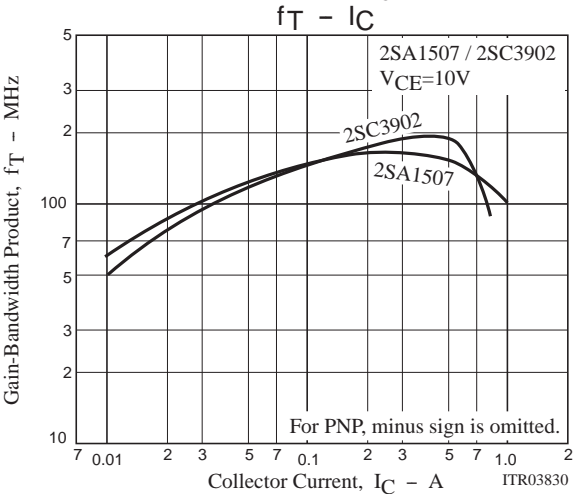
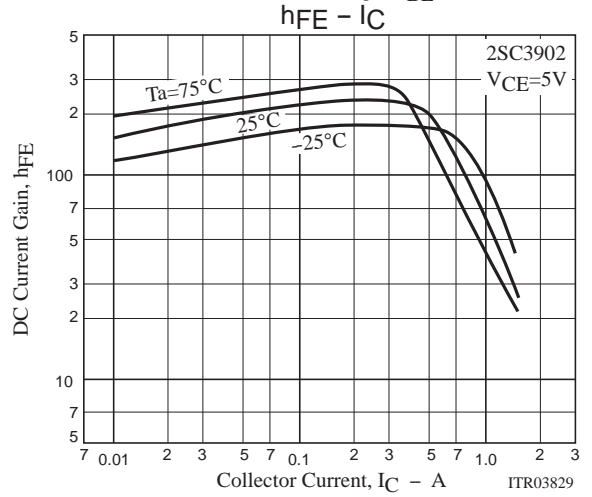
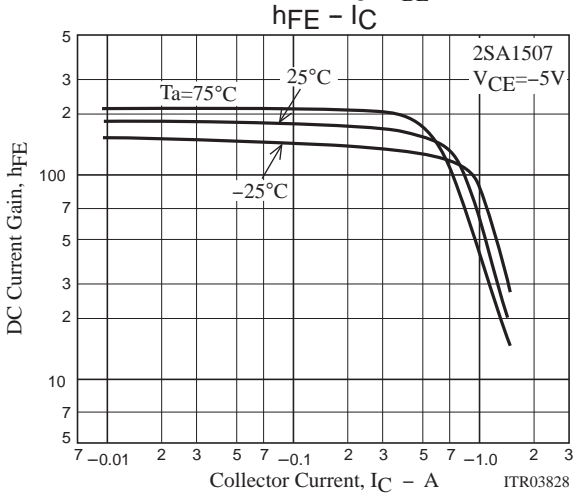
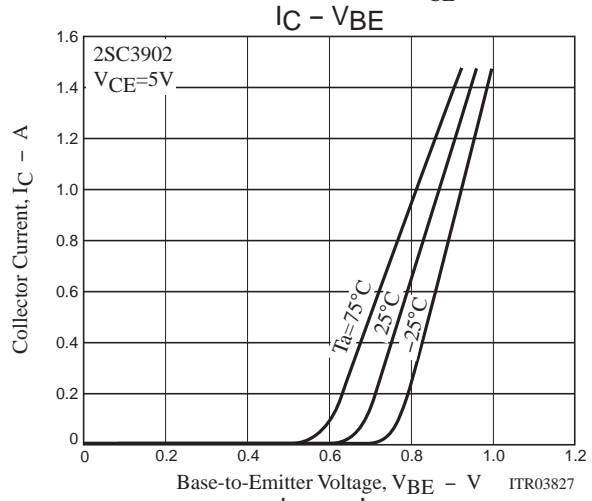
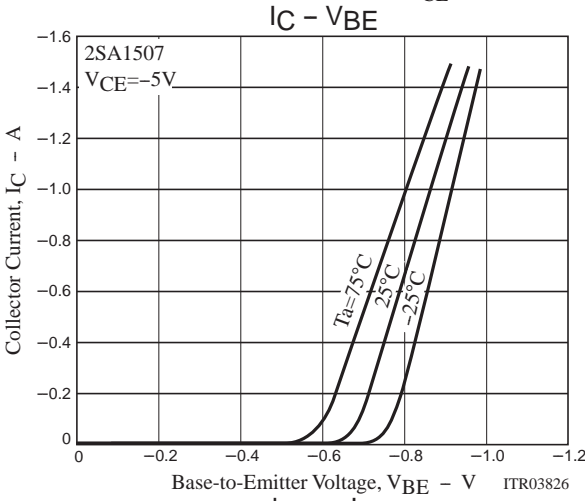
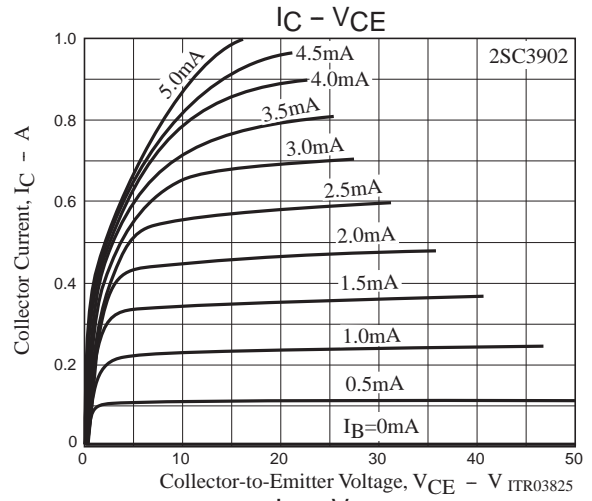
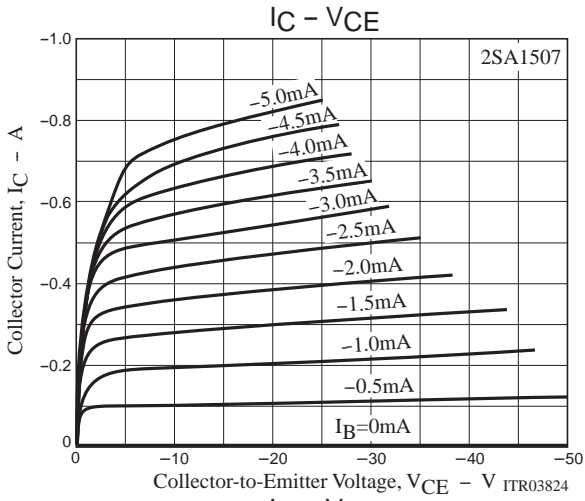

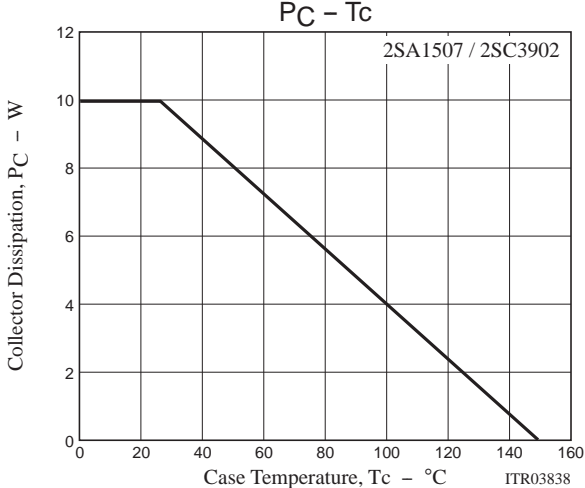
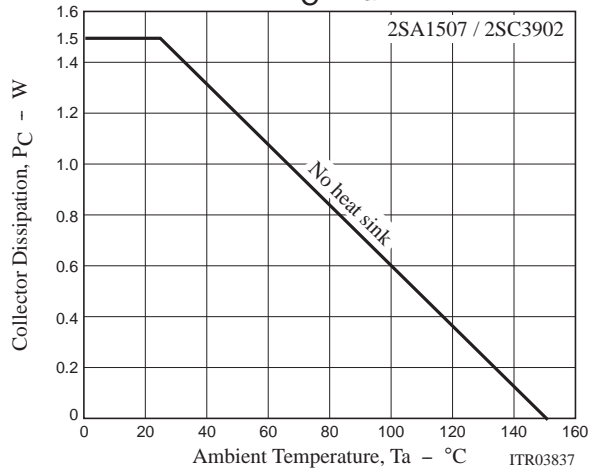
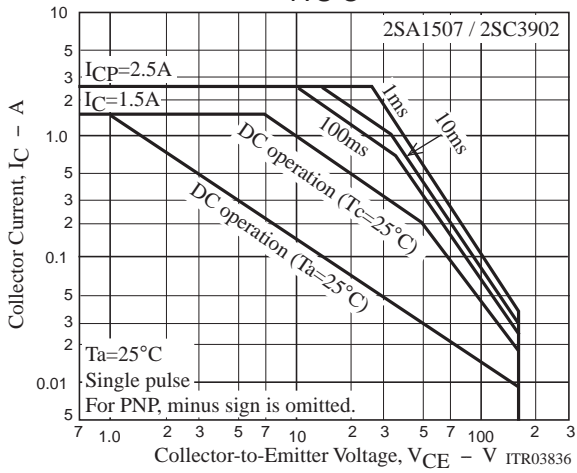
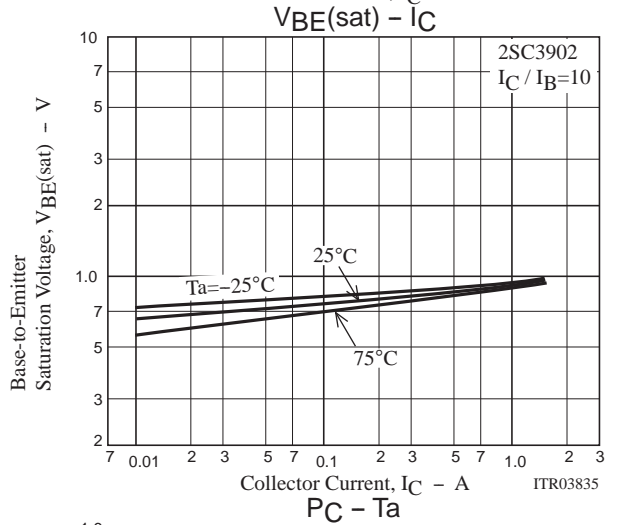
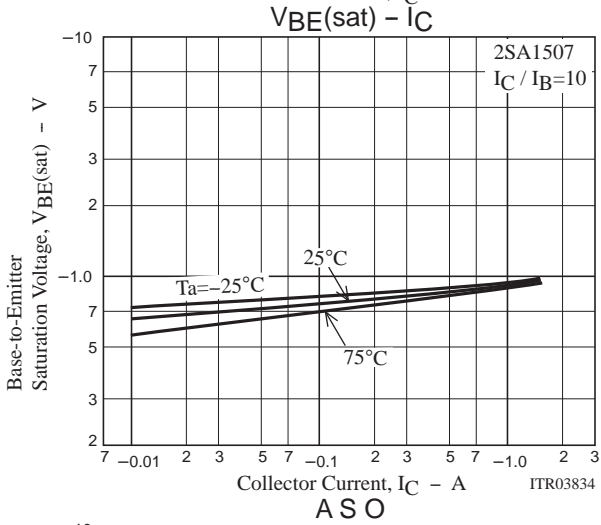
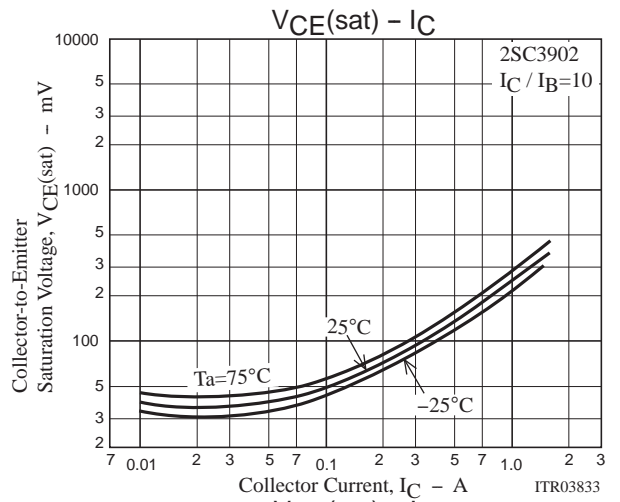
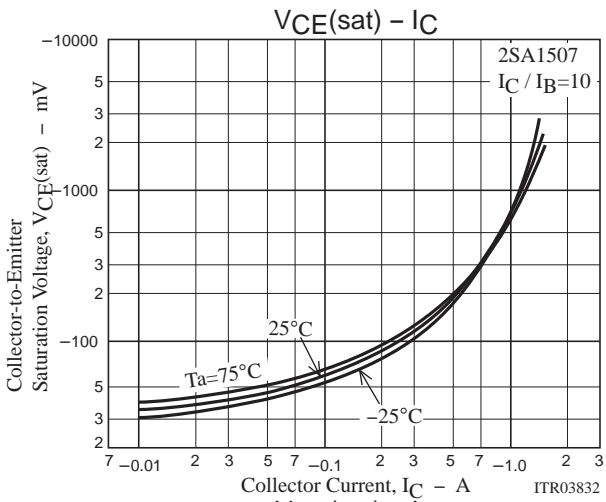

Bag Packing Specification

2SA1507S, 2SA1507T, 2SC3902S, 2SC3902T

1. Packing Format

Package Name	Maximum Number of devices contained (pcs)			Packing format	
	Bag	Inner box	Outer box	Inner BOX	Outer BOX
TO-126ML	200	4,000	12,000	B-1 20 bags contained Dimensions:mm (external) 445×225×55	A-2 3 inner boxes contained Dimensions:mm (external) 470×250×190

2. Bag dimensions

(unit:mm)

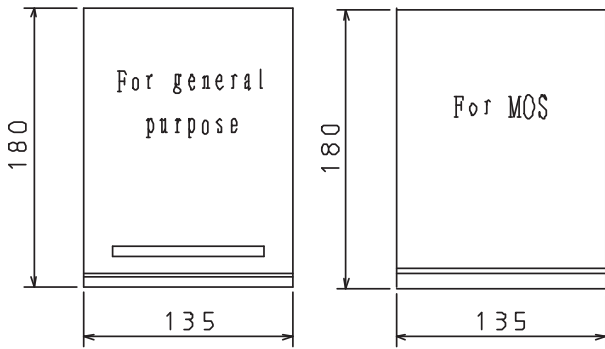

3. Bag label, Inner box label

(unit:mm)

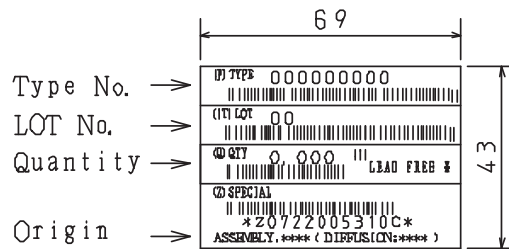

NOTE (1)

The LEAD FREE # description shows that the surface treatment of the terminal is lead free.

Label	JEITA Phase
LEAD FREE 3	JEITA Phase 3A
LEAD FREE 4	JEITA Phase 3

4. Outer box label

(unit:mm)

It is a label at the time of factory shipments.
The form of a label may change in physical distribution process.

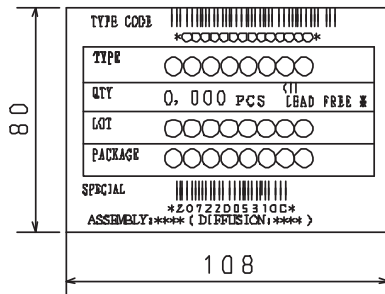

Outline Drawing

2SA1507S, 2SA1507T, 2SC3902S, 2SC3902T

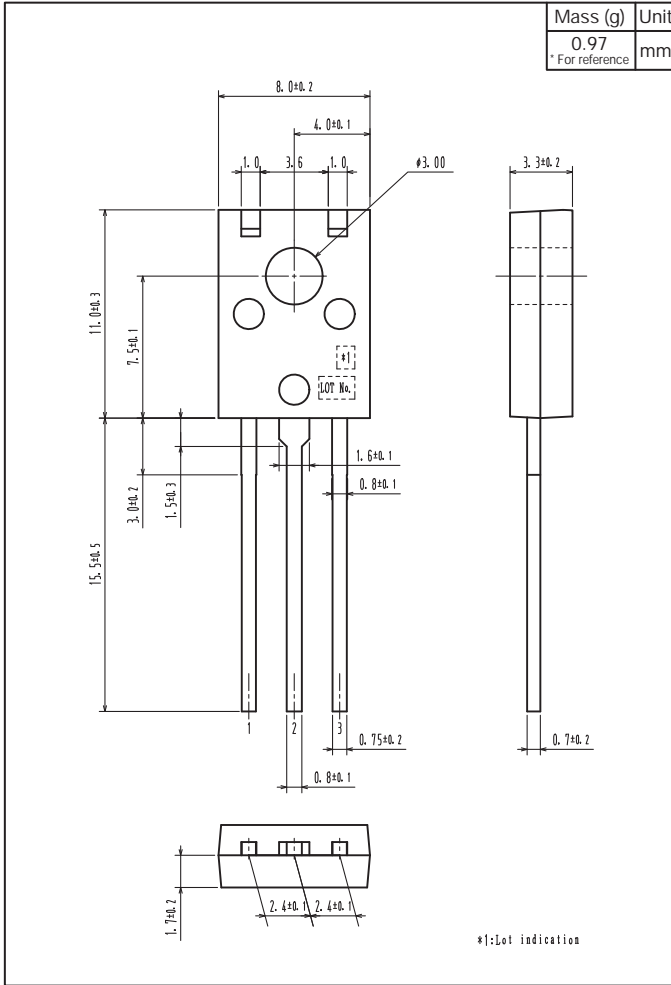

ON Semiconductor and the ON logo are registered trademarks of Semiconductor Components Industries, LLC (SCILLC). SCILLC owns the rights to a number of patents, trademarks, copyrights, trade secrets, and other intellectual property. A listing of SCILLC's product/patent coverage may be accessed at www.onsemi.com/site/pdf/Patent-Marking.pdf. SCILLC reserves the right to make changes without further notice to any products herein. SCILLC makes no warranty, representation or guarantee regarding the suitability of its products for any particular purpose, nor does SCILLC assume any liability arising out of the application or use of any product or circuit, and specifically disclaims any and all liability, including without limitation special, consequential or incidental damages. "Typical" parameters which may be provided in SCILLC data sheets and/or specifications can and do vary in different applications and actual performance may vary over time. All operating parameters, including "Typicals" must be validated for each customer application by customer's technical experts. SCILLC does not convey any license under its patent rights nor the rights of others. SCILLC products are not designed, intended, or authorized for use as components in systems intended for surgical implant into the body, or other applications intended to support or sustain life, or for any other application in which the failure of the SCILLC product could create a situation where personal injury or death may occur. Should Buyer purchase or use SCILLC products for any such unintended or unauthorized application, Buyer shall indemnify and hold SCILLC and its officers, employees, subsidiaries, affiliates, and distributors harmless against all claims, costs, damages, and expenses, and reasonable attorney fees arising out of, directly or indirectly, any claim of personal injury or death associated with such unintended or unauthorized use, even if such claim alleges that SCILLC was negligent regarding the design or manufacture of the part. SCILLC is an Equal Opportunity/Affirmative Action Employer. This literature is subject to all applicable copyright laws and is not for resale in any manner.